

1.5 MP 2/3" Fixed-Focal

GMHR31214MCN

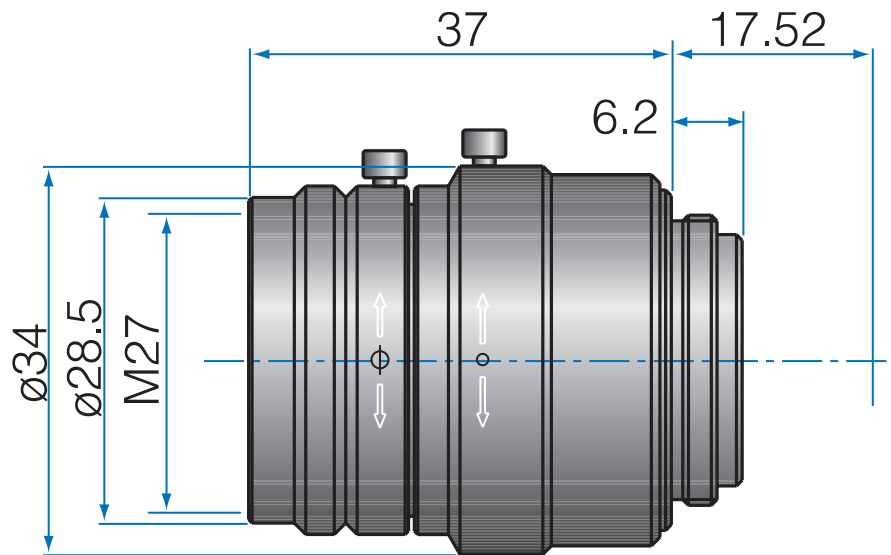

Part No.	GMHR31214MCN
Focal Length	12mm
Iris Range	f/1.4-Close
Lens Format	2/3"
Resolution	120 lp/mm
MOD	150mm
Mount	C
Filter Thread	M27 x P0.5
Angle of View (HxVxD) 1/2"	28.3° x 21.1° x 35.0°
Angle of View (HxVxD) 2/3"	38.3° x 26.2° x 46.8°
Weight	75g
Dimension (DxL)	Ø34 x 37