

## High Resolution 2/3" Fixed-Focal GMN33516MCN-1

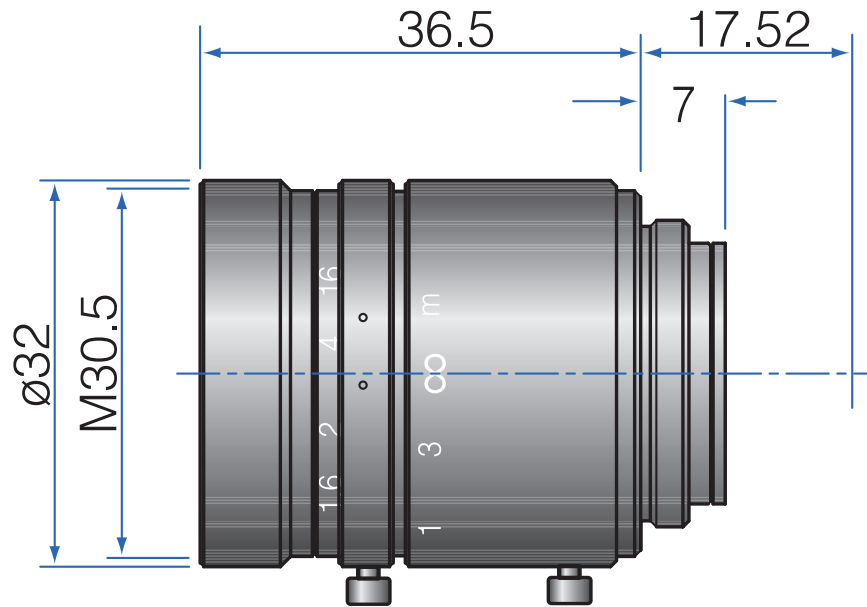

Part No.	GMN33516MCN-1
Focal Length	35mm
Iris Range	f/1.6-16
Lens Format	2/3"
Resolution	100 lp/mm
MOD	350mm
Mount	C
Filter Thread	M30.5xP0.5
Angle of View (HxVxD) 1/2"	10.5° x 7.9° x 13.1°
Angle of View (HxVxD) 2/3"	14.4° x 10.8° x 17.9°
Weight	75g
Dimension (DxL)	$\varnothing 32$ x 36.5