

High Resolution 2/3" Fixed-Focal  
**GM35018MCN**

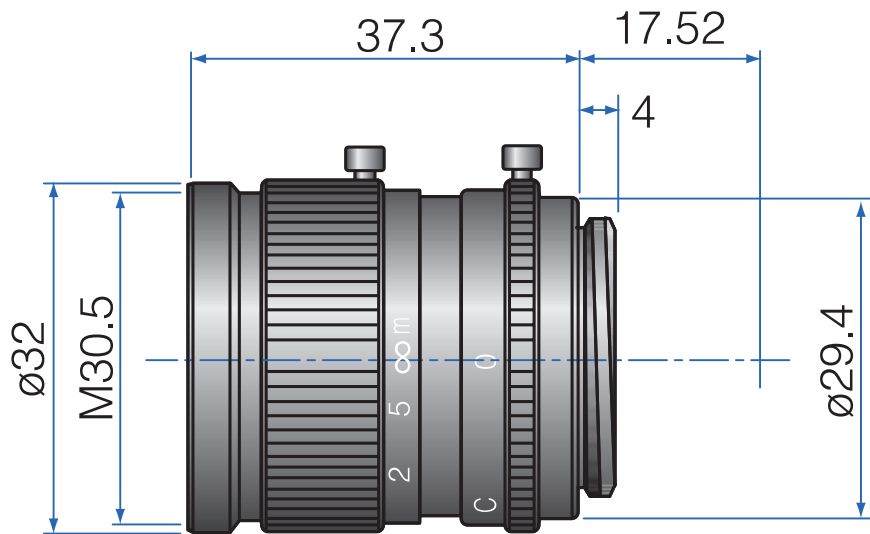

Part No.	GM35018MCN
Focal Length	50mm
Iris Range	f/1.8-Close
Lens Format	2/3"
Resolution	100 lp/mm
MOD	1000mm
Mount	C
Filter Thread	M30.5xP0.5
Angle of View (HxVxD) 1/2"	7.4° x 5.4° x 9.3°
Angle of View (HxVxD) 2/3"	10.3° x 7.5° x 13.0°
Weight	55g
Dimension (DxL)	Ø32 x 37.3