

High Resolution 2/3" Fixed-Focal GM32514MCN

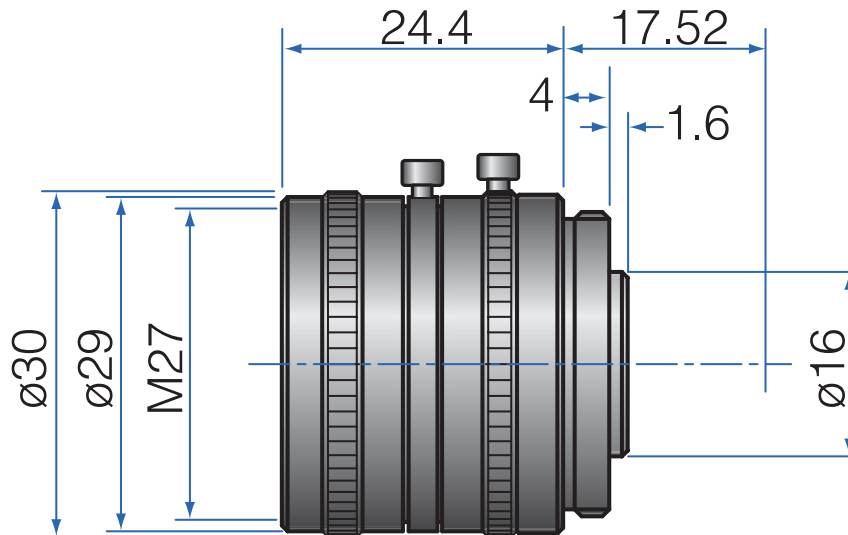

Part No.	GM32514MCN
Focal Length	25mm
Iris Range	f/1.4-Close
Lens Format	2/3"
Resolution	100 lp/mm
MOD	500mm
Mount	C
Filter Thread	M27xP0.5
Angle of View (HxVxD) 1/2"	14.3° x 10.5° x 18.11°
Angle of View (HxVxD) 2/3"	19.5° x 15.1° x 25.2°
Weight	40g
Dimension (DxL)	Ø30 x 24.5