

3 Motorized Zoom 1/2" Varifocal **GAZ10550M**

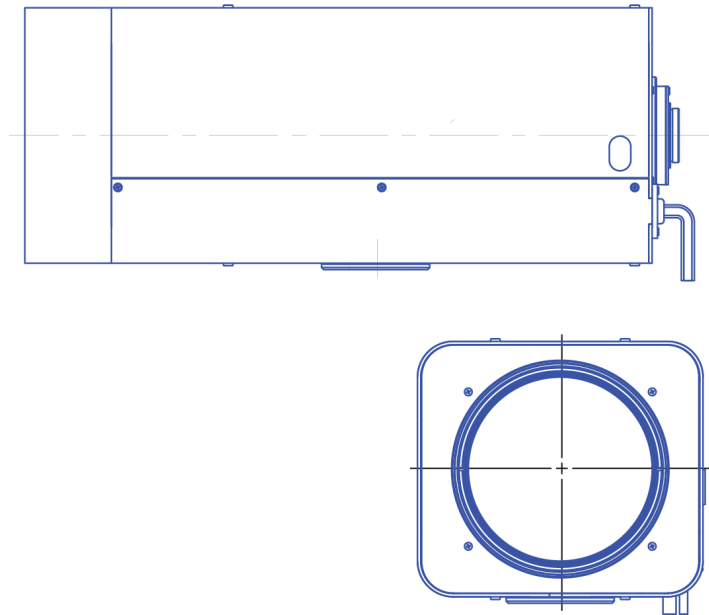

Part No.	GAZ10550M
Focal Length	10-550mm
Iris Range	f/3.8-Close
Lens Format	1/2"
MOD	5000mm
Mount	C
Filter Thread	M95 x P1.0
Angle of View (HxV) 1/2"	0.69° - 34.57°
Weight	4070g
Dimension (WxHxL)	Ø132 x 121 x 299