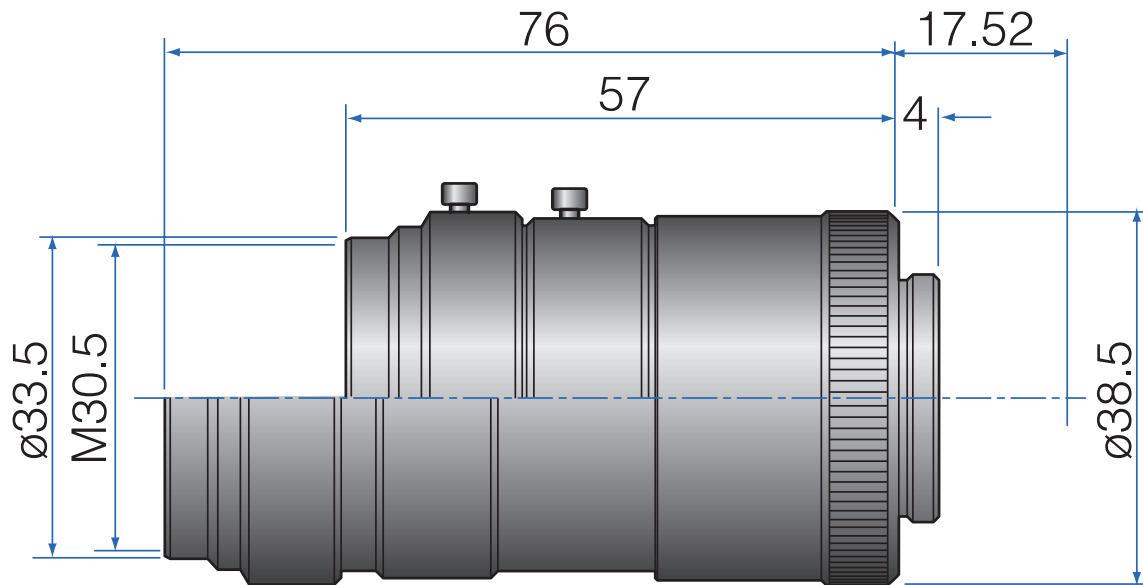

5 MP 2/3" Fixed-Focal

GMB5HR35028MCN

Part No.	GMB5HR35028MCN
Focal Length	50mm
Iris Range	f/2.8-22
Lens Format	2/3"
Resolution	160 lp/mm
MOD	200mm
Mount	C
Filter Thread	M30.5 x P0.5
Angle of View (HxVxD) 2/3"	9°6' x 7°2' x 11°9'
Weight	120g
Dimension (DxL)	Ø38.5 x 76.0